

Outdoor Display
Star Tent - ST510-XAF

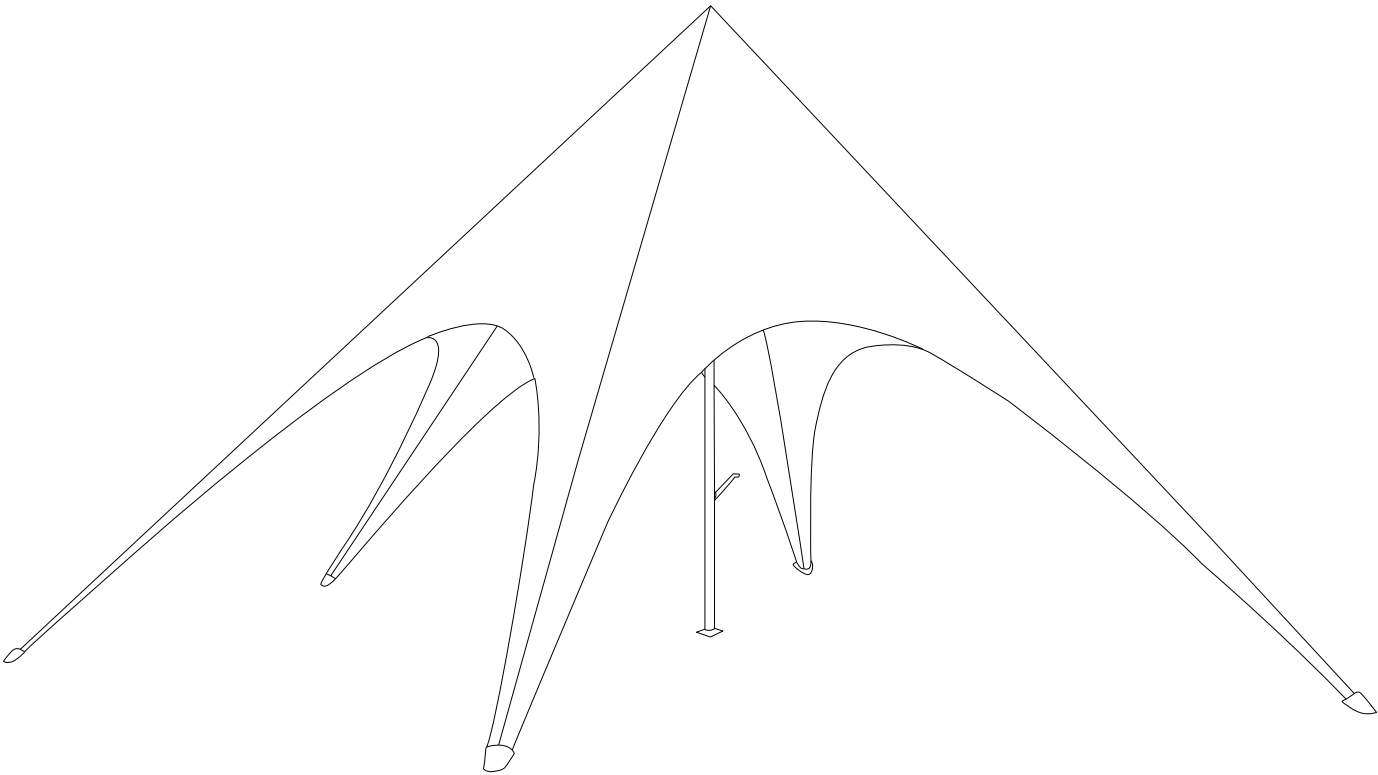

Kit Contents

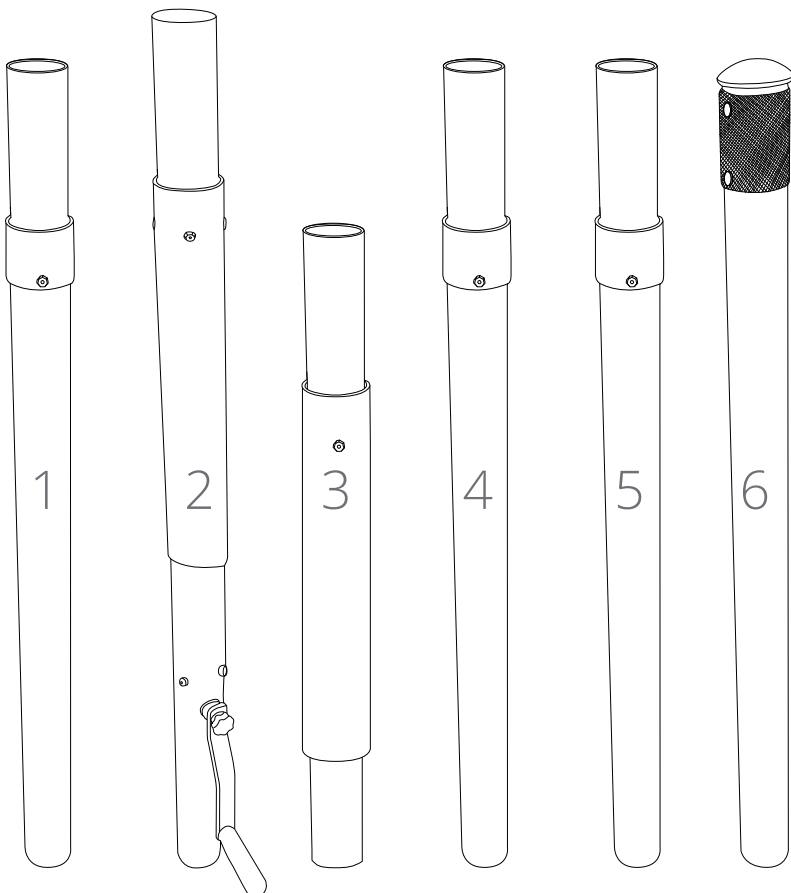
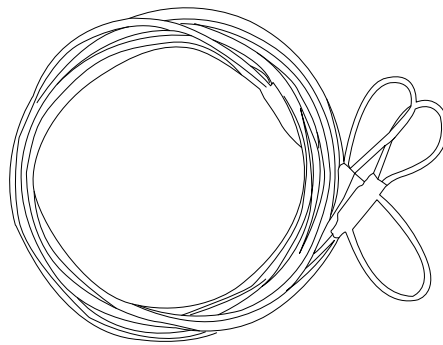
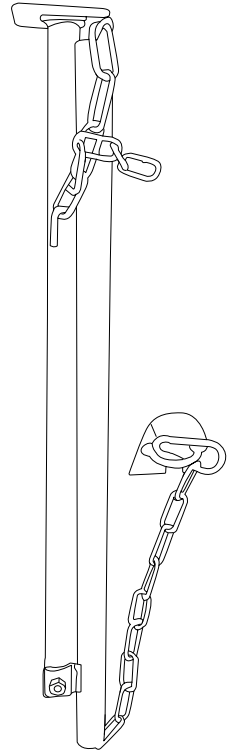
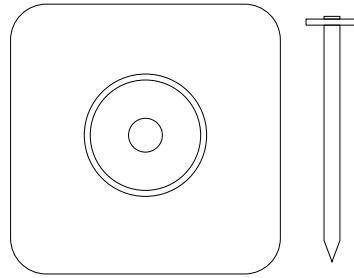
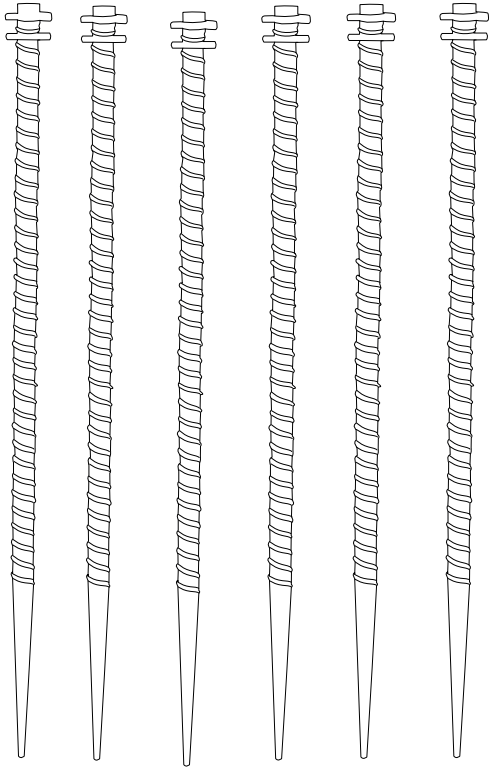

Required Tools

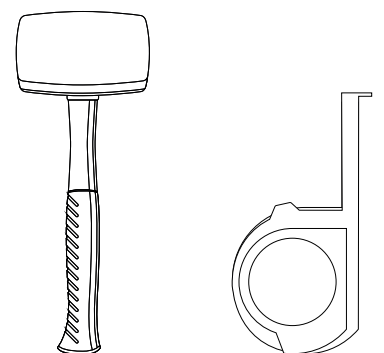

Assembly

1

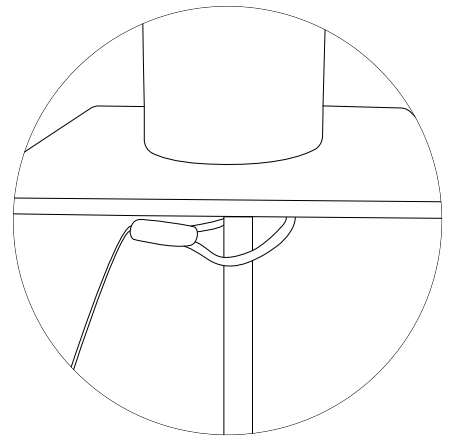
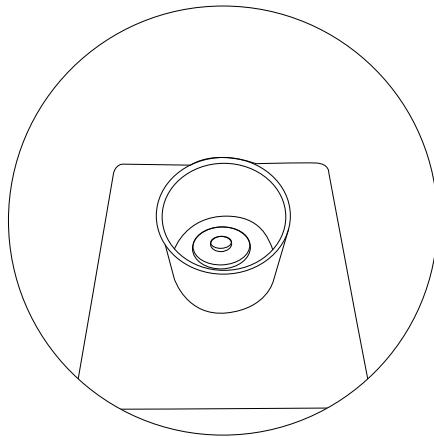
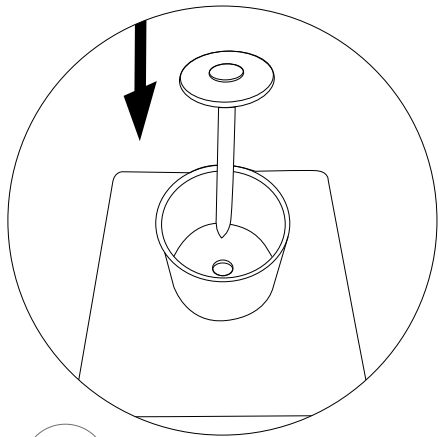
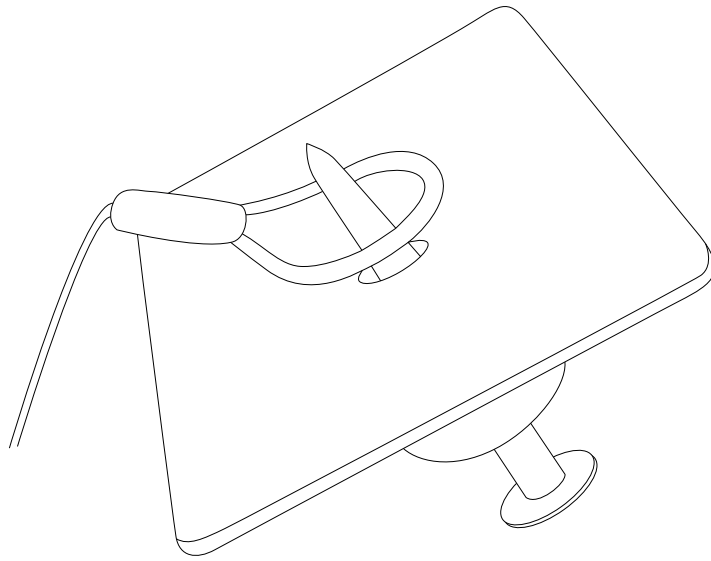

2

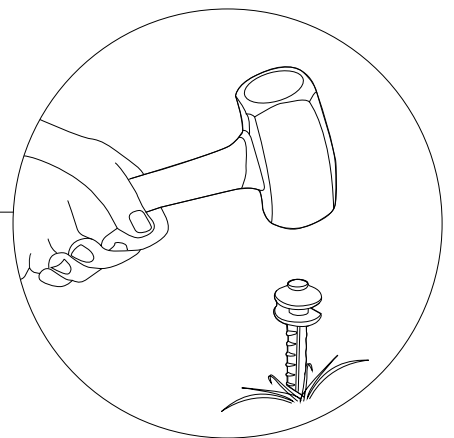
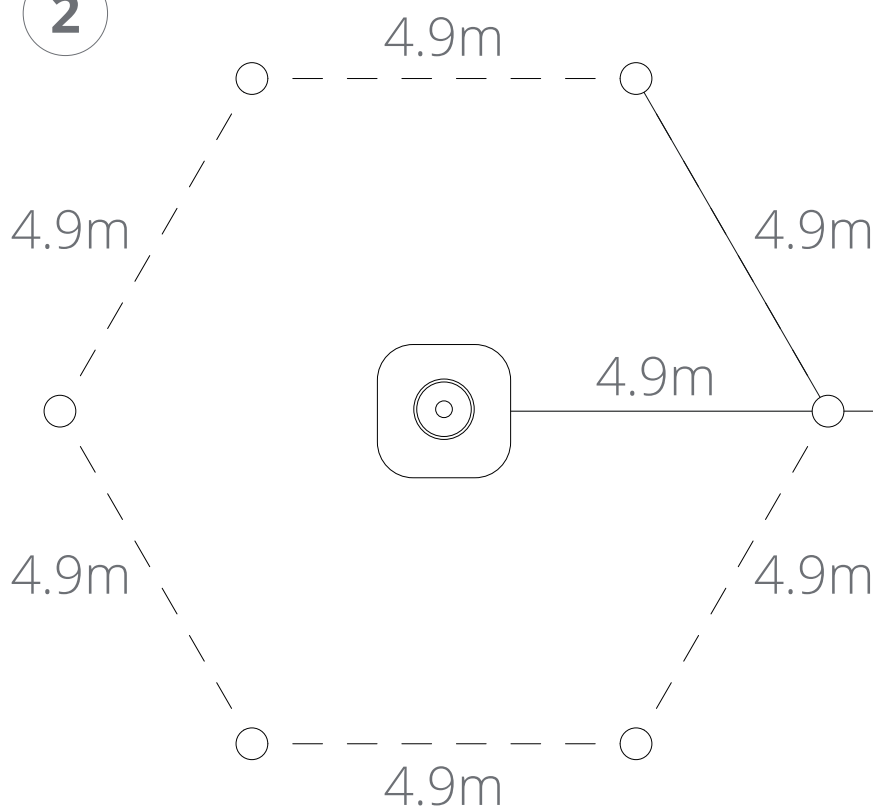

Leave x2 inches above ground

3

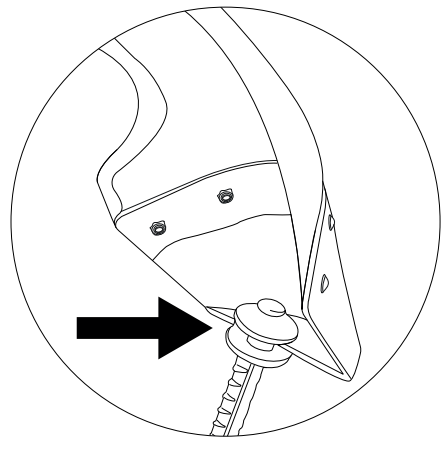
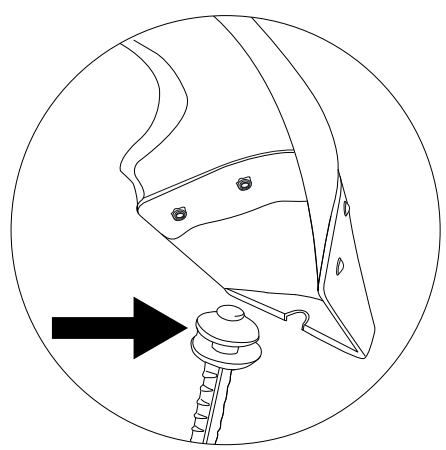
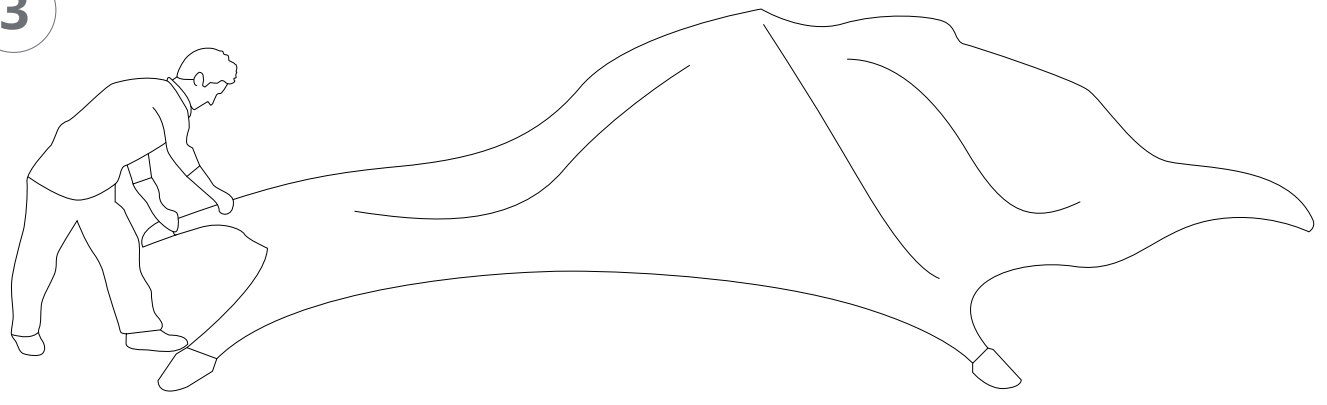

Attach x5 canopy legs

4

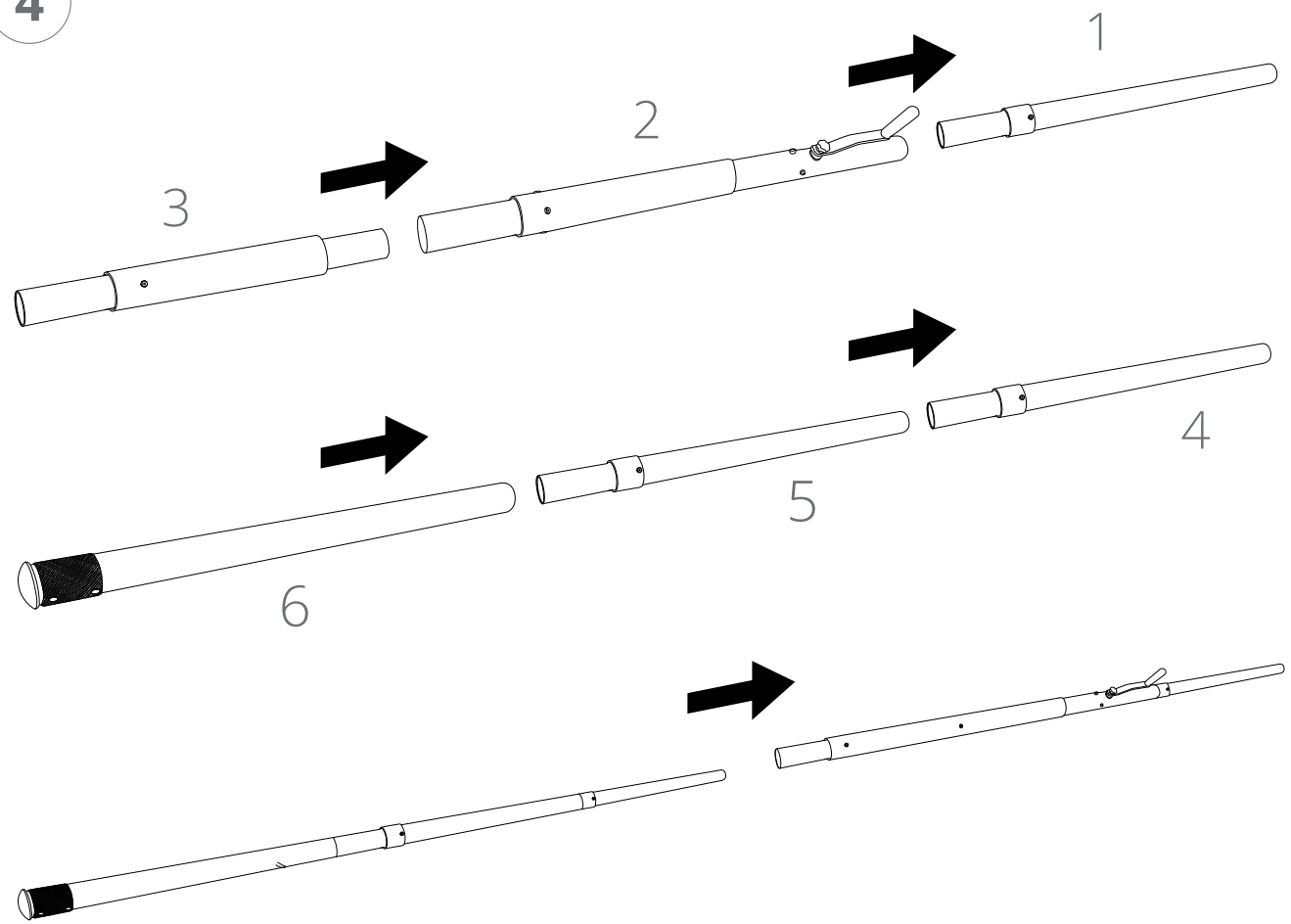

4

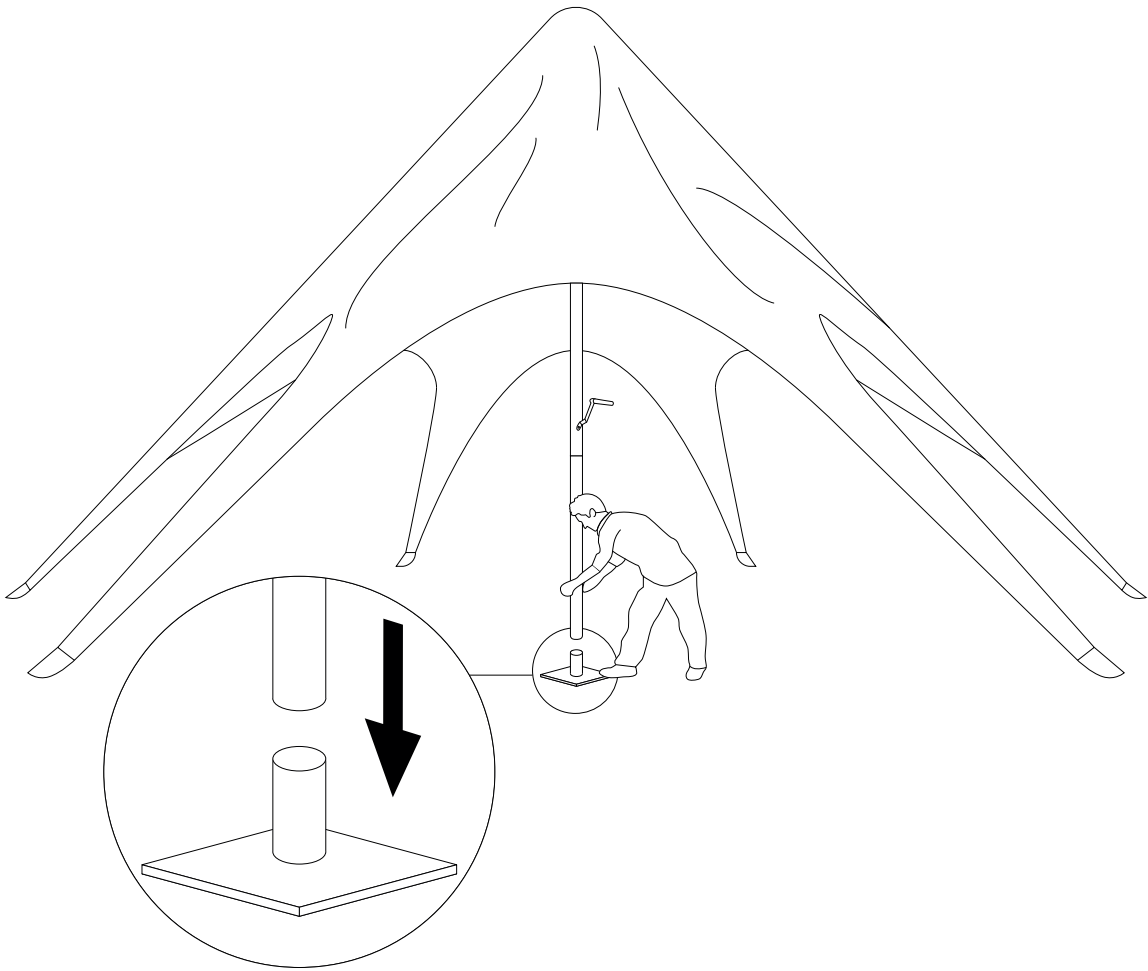

5

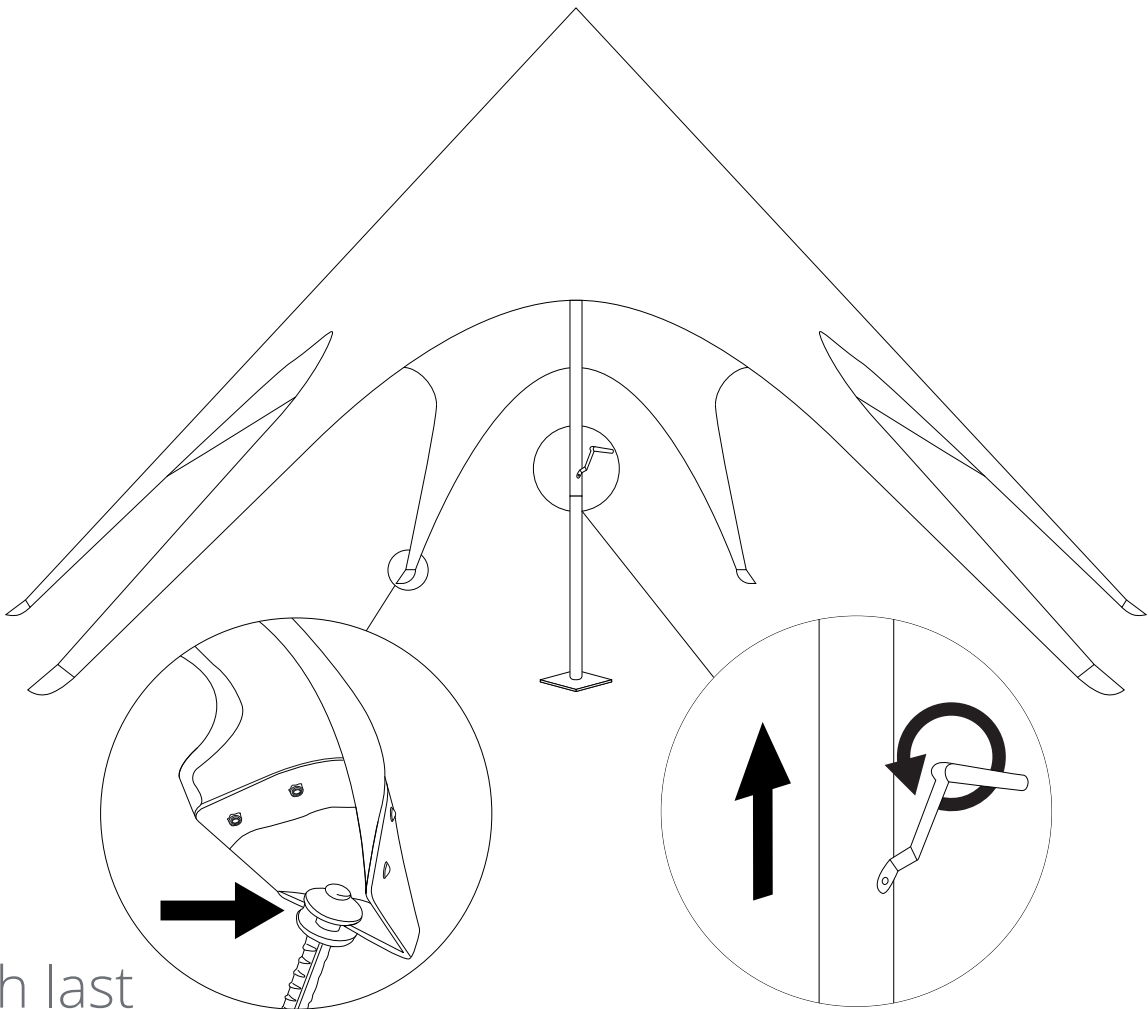

Attach last canopy leg

Disassembly

